

## Venus Pull Out Spray Sink Mixer

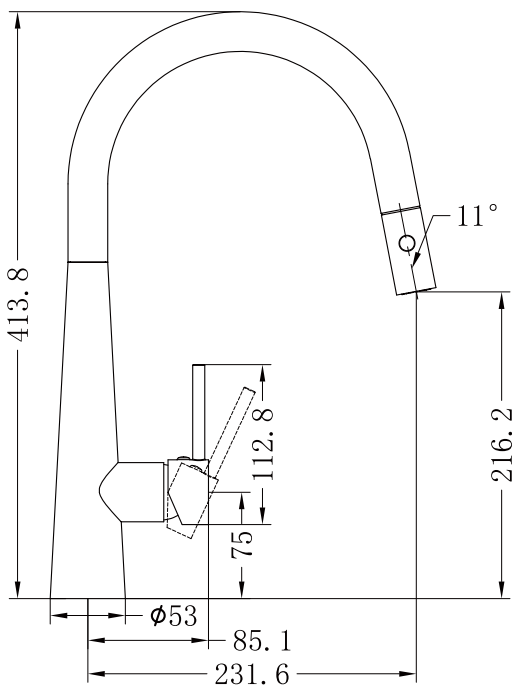





Dimensions are nominal measurements only.

### SPECIFICATION

|                    |                       |
|--------------------|-----------------------|
| WELS RATING        | 5 STAR 5L/MIN         |
| WATERMARK LICENSE  | WM-060073             |
| TEMPERATURE RATING | MIN 1°C-MAX 75°C      |
| PRESSURE RATING    | MIN 150KPa-MAX 500KPa |

### FINISH

|   |                               |   |                            |
|---|-------------------------------|---|----------------------------|
|  | CHROME<br>NR581009cCH         |  | MATTE BLACK<br>NR581009cMB |
|  | BRUSHED NICKEL<br>NR581009cBN |  | GUN METAL<br>NR581009cGM   |
|  | BRUSHED GOLD<br>NR581009cBG   |   |                            |

### MAINTENANCE AND CARE

All surfaces should be cleaned with mild liquid detergent or soap and water.

Do not use cream cleaners or citrus based cleaning products, as they are abrasive.

Use of unsuitable cleaning agents may damage the surface. Any damage caused in this way will not be covered by warranty.

### PACKING INCLUDES

- 1x sink mixer
- 2x flexible hose
- 1x hose tail
- 1x counter weight



Versions: V1

## Installation Instruction

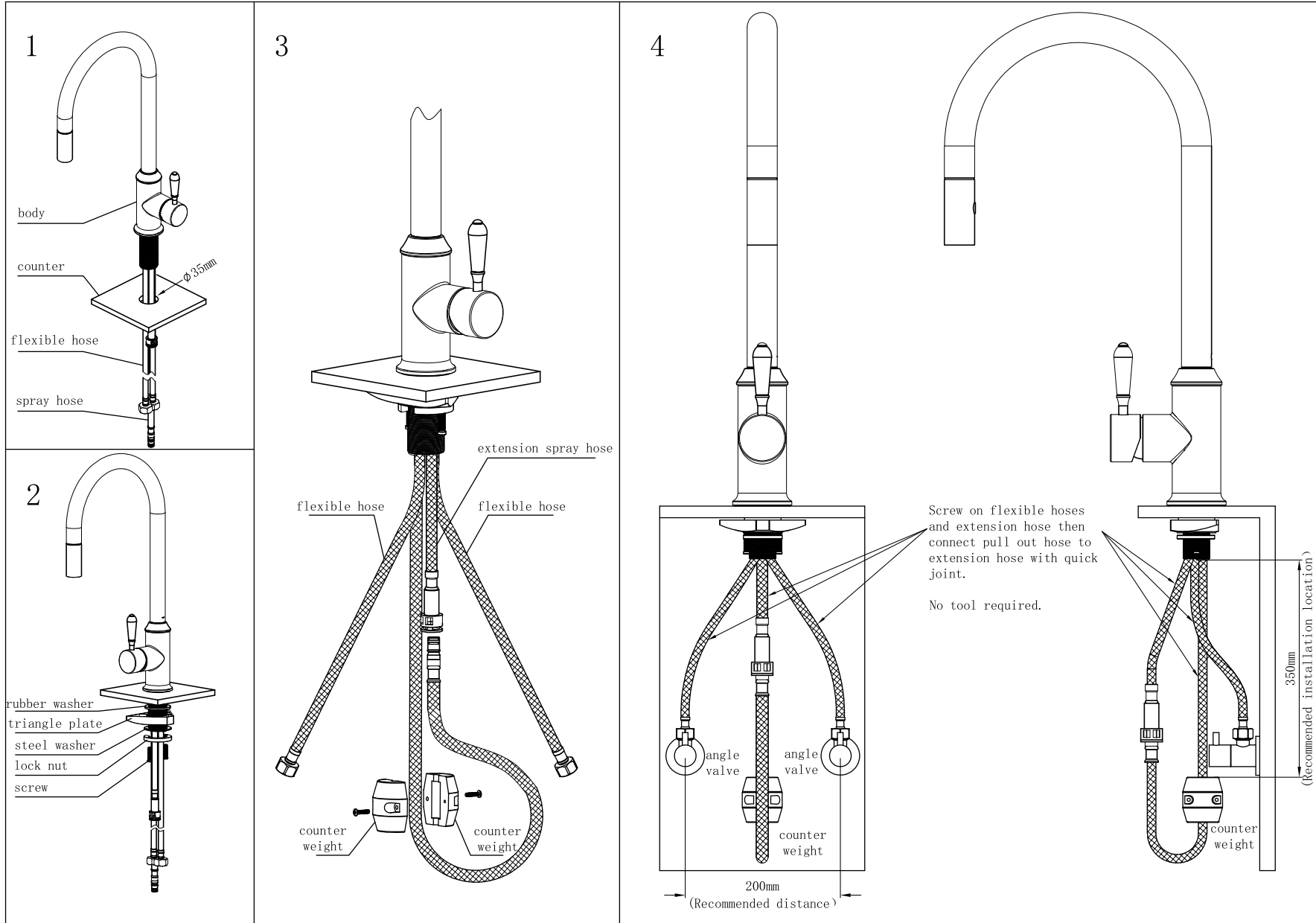

### NOTE:

